

EENS 2110	Mineralogy
Tulane University	Prof. Stephen A. Nelson
<b>Biaxial Minerals</b>	

This document last updated on 04-Nov-2011

All minerals that crystallize in the orthorhombic, monoclinic, or triclinic crystal systems are biaxial. Biaxial crystals have 2 optic axes, and this distinguishes biaxial crystals from uniaxial crystals. Like uniaxial crystals, biaxial crystals have refractive indices that vary between two extremes, but also have a unique intermediate refractive index. Biaxial refractive indices are as follows:

- The smallest refractive index is given the symbol  $\alpha$  (or X).
- The intermediate refractive index is given the symbol  $\beta$  (or Y).
- The largest refractive index is given the symbol  $\gamma$  (or Z)

All biaxial minerals have optical symmetry equivalent to  $2/m2/m2/m$ . But, in each of the crystal systems, the optical directions have different correspondence to the crystallographic directions.

- In orthorhombic crystals the optical directions correspond to the crystallographic axes, i.e. the X direction and its corresponding refractive index,  $\alpha$  can be either the a, b, or c crystallographic axes, the Y direction and  $\beta$  can be parallel to either a, b, or c, and the Z direction or  $\gamma$ , can be parallel to either a, b, or c.
- In monoclinic crystals, one of the X ( $\alpha$ ), Y ( $\beta$ ), or Z ( $\gamma$ ) directions or indices is parallel to the b crystallographic axis, and the other two do not coincide with crystallographic directions.
- In triclinic crystals none of the optical directions or indices coincide with crystallographic directions, although in some rare case one of the indices might coincide with one of the crystallographic directions.

### The Biaxial Indicatrix

The biaxial indicatrix, like the isotropic and uniaxial indicatrices, diagrammatically illustrates the refractive index for vibration directions of light. It is shown in the diagram below.

The biaxial indicatrix has three principle axes, labeled  $\alpha$ ,  $\beta$ , and  $\gamma$ . Directions that have refractive indices between  $\alpha$  and  $\beta$ , are referred to as  $\alpha'$ . Directions with refractive indices between  $\gamma$  and  $\beta$  are referred to as  $\gamma'$ . Note that the  $\beta$  direction also must occur in the plane that includes  $\alpha$  and  $\gamma$ . Similarly, if we were to draw all other possible planes that include the  $\gamma$  direction,  $\beta$  would have to occur in each of these as well. This results in two sections that would be circular with a radius equivalent to the  $\beta$  refractive index. These two sections are referred to as the circular sections. In the diagrams below we see the two circular sections, each having a radius equal to the  $\beta$  refractive index.

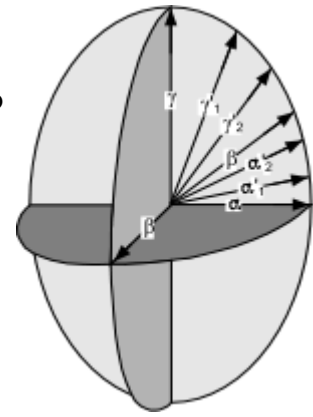

In the left-hand diagram some of the other possible planes that include  $\gamma$  are shown. In the right-hand diagram these planes are removed to show only the circular sections. Lines drawn perpendicular to the circular sections are the optic axes. This is why minerals that exhibit these optical properties are called biaxial.

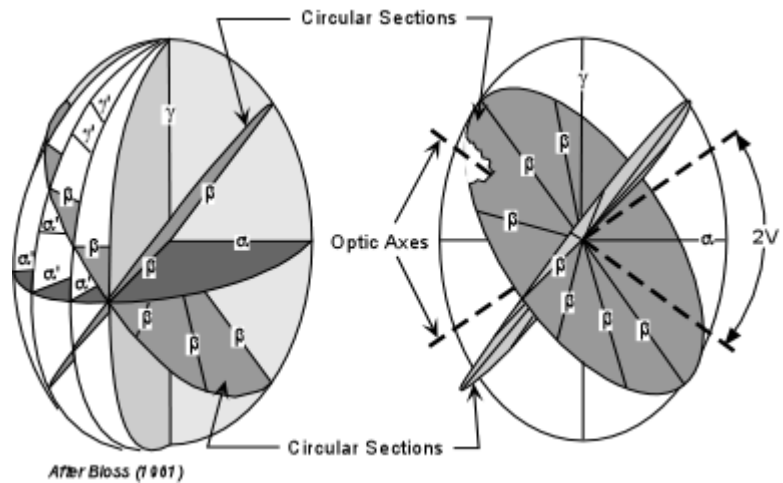

The acute angle between the optic axes is called the  $2V$  angle.

Just like in uniaxial minerals, if one is looking down one of the optic axes, light traveling along the optic axis will be vibrating in the  $\beta$  direction, and thus the mineral would be extinct for all rotation positions.

The three principal planes of the biaxial indicatrix are shown here. The plane containing the  $\alpha$  and  $\gamma$  directions also contains the optic axes, which are perpendicular to the  $\beta$  directions. This plane is called the *optic axial plane* or *OAP*.

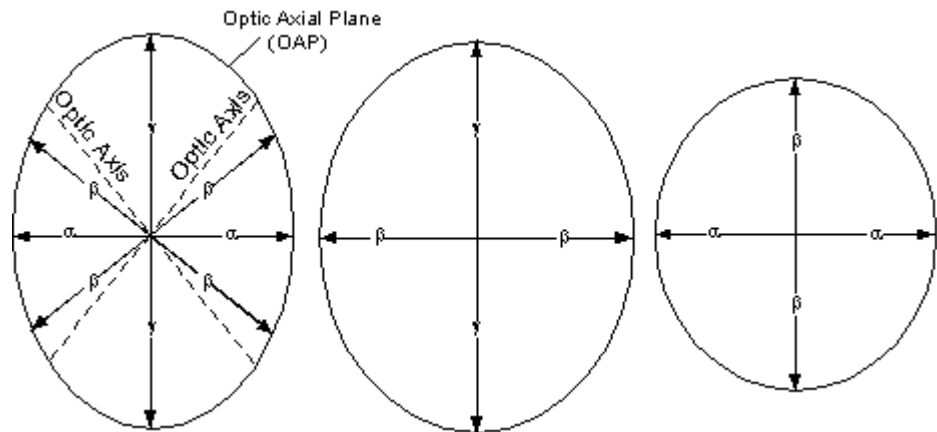

The other two principal planes contain the  $\gamma$  and  $\beta$  directions and the  $\alpha$  and  $\beta$  directions, respectively.

## Optic Sign of Biaxial Minerals

The optic sign of biaxial minerals depends on whether the  $\beta$  refractive index is closer to that of  $\alpha$  or to  $\gamma$ . There are several ways that this can be stated, so we will look at all of them.

### Biaxial Positive

- A mineral is biaxial positive if  $\beta$  is closer to  $\alpha$  than to  $\gamma$ .
- In this case the acute angle,  $2V$ , between the optic axes is bisected by the  $\gamma$  refractive index direction. Thus we say that  $\gamma$  is the **acute bisectrix ( $BX_A$ )**, because it bisects this angle.
- If a table of optical properties of minerals reports the  $2V$  angle, it usually refers to this acute angle. But some tables report the  $2V$  as  $2V_\gamma$  or  $2V_\alpha$ . Note that in the case of a biaxial positive mineral,  $2V_\gamma$  is the acute bisectrix, while  $2V_\alpha$  bisects the obtuse angle between the optic axes (called the **obtuse bisectrix ( $BX_O$ )**).

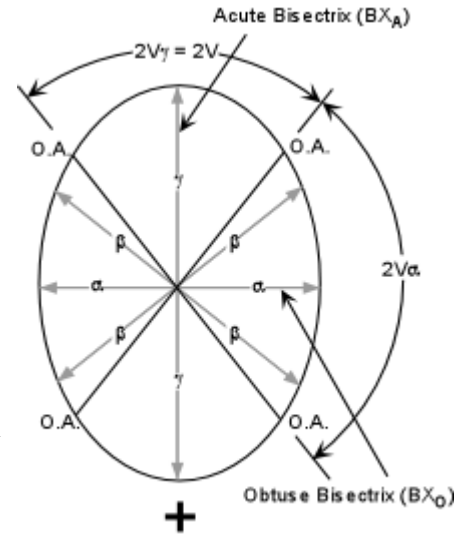

### Biaxial Negative

- A mineral is biaxial negative if  $\beta$  is closer to  $\gamma$  than to  $\alpha$ .
- In this case the acute angle,  $2V$ , between the optic axes is bisected by the  $\alpha$  refractive index direction. Thus we say that  $\alpha$  is the acute bisectrix.
- In the case of a biaxial negative mineral,  $2V_\alpha$  is the acute bisectrix, while  $2V_\gamma$  is the obtuse bisectrix.
- Note that  $2V_\alpha + 2V_\gamma = 180^\circ$ .
- If  $2V = 90^\circ$  the mineral has no optic sign.
- If  $2V = 0^\circ$  the mineral is uniaxial.

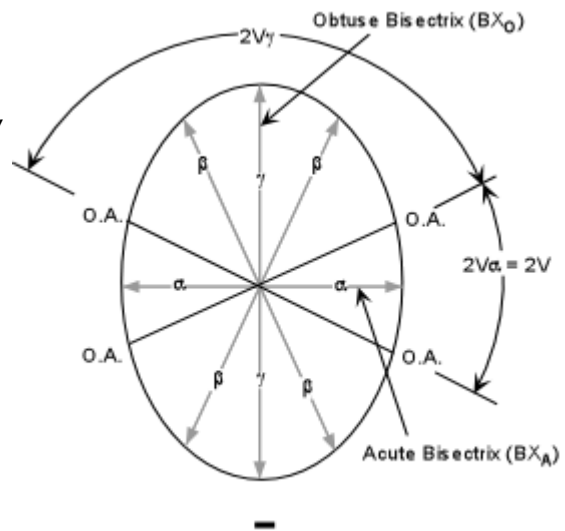

## Optical Orientations of Biaxial Crystals

Just like in uniaxial crystals, we can move the indicatrix around in a crystal so long as the indicatrix is kept parallel to the optical directions, and use this as an aid to determining the

optical directions in the crystal. Several orientations are possible, the most general are shown in the diagram below. Note that in this diagram we have not shown the crystallographic axes, because different minerals will show different relationships between optical directions and crystallographic directions as discussed above.

- If a crystal oriented on the microscope stage with its  $\alpha$  vibration direction perpendicular to the stage, then the  $\beta$  and  $\gamma$  vibration directions will be the two privileged directions in the crystal, as for the face labeled A in the diagram below. With such a face it would be possible to determine the  $\beta$  and  $\gamma$  refractive indices by using the Becke line method and various oils when either of these privileged directions is oriented parallel to the polarizer. Just as in uniaxial minerals, the crystal would be extinct with the analyzer inserted when either of the privileged directions are parallel to the polarizer. At any other orientation of the two principal vibration directions the crystal would exhibit an interference color that reflects the thickness of the crystal and the birefringence for this orientation ( $\gamma - \beta$ ). Note that this would **not** be the maximum interference color for this crystal.

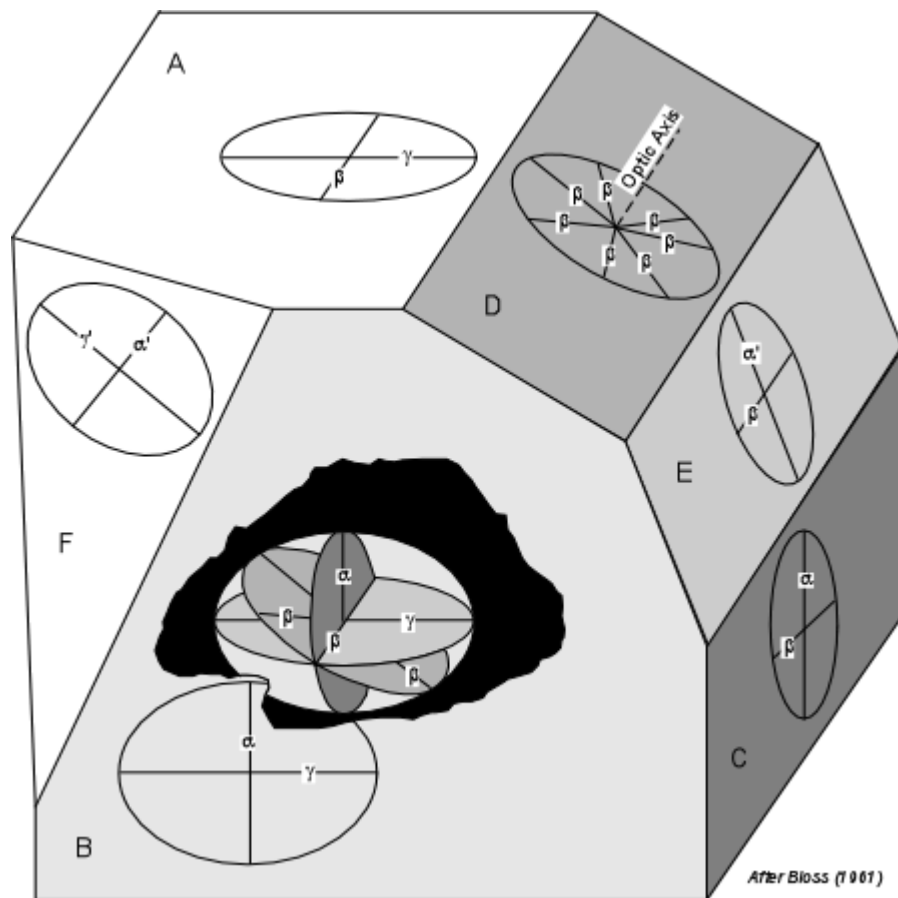

- If a crystal face such as B in the diagram above is parallel to the microscope stage, one would be looking down the  $\beta$  direction in the crystal. In this orientation the optic axial plane (OAP) would be parallel to the stage, and the  $\alpha$  and  $\gamma$  refractive indices could be determined using the Becke line method and various oils. Because the  $\beta$  direction in this orientation is perpendicular to or normal to the OAP, the  $\beta$  direction is often referred to as the optic normal direction (O.N.).

In this orientation the interference color exhibited by positions off of extinction would again reflect the thickness of the crystal and the birefringence. But the birefringence for this orientation would be the absolute or maximum birefringence possible for this crystal ( $\gamma - \alpha$ ).

- If a face like C were lying parallel to the stage, it would show another of the principal planes of the indicatrix, this time showing the  $\alpha$  and  $\beta$  vibration directions of the crystal. Again, the refractive indices corresponding the  $\alpha$  and  $\beta$  could be determined in this orientation. Note that for crystal faces A or C, we would be looking down either the  $BX_A$  or  $BX_O$  depending on the optic sign of the mineral. The interference color seen with the analyzer inserted will reflect an intermediate birefringence for the crystal ( $\beta - \alpha$ ).
- If a face like D were lying parallel to the stage, it would show the circular section and one of the optic axes would be orientated perpendicular to the stage. For this orientation the crystal would show no change in relief on rotation of the stage with the analyzer not inserted, and would remain extinct through a  $360^\circ$  rotation with crossed polarizers. For any rotation position the  $\beta$  refractive index could be determined.
- Faces like E and F, if lying parallel to the stage, would have privileged directions corresponding to random vibration directions.  $\alpha'$ ,  $\gamma'$  and  $\beta$  could be measured, but this would be of little use because all of these refractive indices are intermediate.

While knowledge of the optical directions can provide a means to measure the principle refractive indices, this is not often done because much of the information necessary to identify a biaxial mineral can be obtained from interference figures.

### Biaxial Interference Figures

Four primary types of biaxial interference are seen. Only two of these are commonly used, but it is essential to discuss all four so that you can recognize each.

#### Acute Bisectrix Figure ( $BX_A$ )

Looking down the acute bisectrix, (the  $\gamma$  direction perpendicular to the stage if the crystal is optically positive, or the  $\alpha$  direction perpendicular to the stage if the crystal is negative), at  $45^\circ$  off extinction in conoscopic mode, one would see the interference figure shown in the left-hand diagram below.

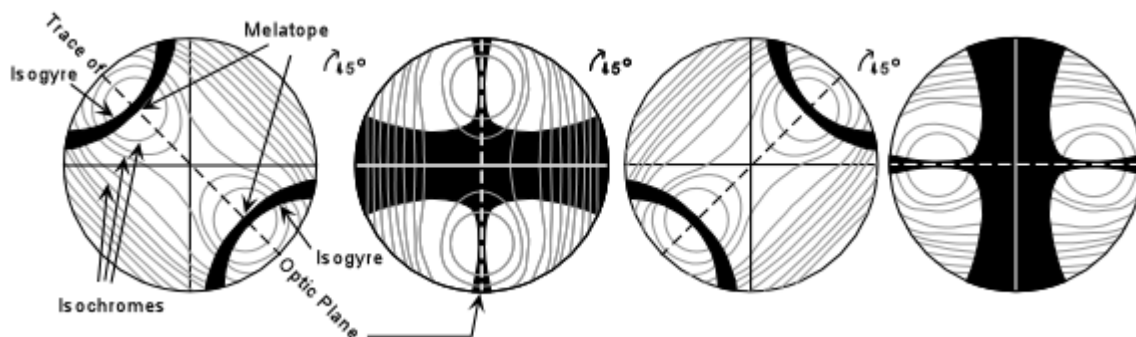

- The dark isogyres mark the positions where light vibrating parallel to the polarizer has

passed through the crystal.

- At the points of maximum curvature of the isogyres are the two melatopes that mark the positions where rays that traveled along the optic axis emerge from the field of view.
- Note that the distance between the two melatopes is proportional to the angle  $2V$  between the optic axes.
- Also seen are isochromes, which show increasing interference colors in all directions away from the melatopes. The number of isochromes and maximum order of the interference colors seen will increase with increasing thickness and absolute birefringence of the crystal.
- Shown in the figure is the trace of the optic axial plane which includes the two optic axes.

As the stage is rotated  $45^\circ$  from this initial position, the isogyres will close to produce a cross. In this position the crystal would be extinct in orthoscope mode. The melatopes will be rotated so that both lie along the N-S cross hair.

Rotation by an additional  $45^\circ$  will result in the isogyres then separating again to show the interference figure in the third diagram. Another  $45^\circ$  rotation will again cause the isogyres to close into a cross, this time with the OAP lying parallel to the polarizing direction of the microscope. The crystal would again be extinct in orthoscope mode. Another  $45^\circ$  rotation would return the view to the first diagram in the series.

### Optic Axis Figure (OA)

If one of the optic axes is oriented perpendicular to the stage, placing the microscope in conoscope mode will result in an optic axis interference figure. This is similar to the  $BX_A$  figure, except one of the isogyres and melatopes will be outside of the field of view (unless the  $2V$  angle is very small).

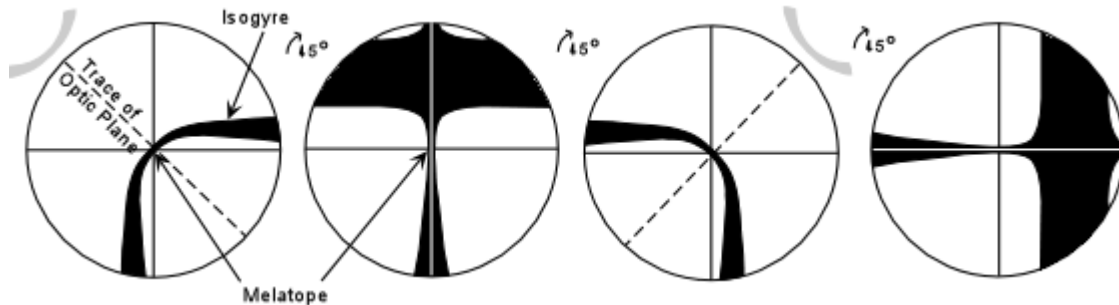

During rotation of the stage, the melatope will remain at the cross-hair intersection and the isogyres will close to form an off-centered cross and then separate to show the curved isogyre in the adjacent quadrant of the field of view.

OA figures are easiest to find among randomly oriented grains, because a grain that shows such a figure will show no change in relief on a  $360^\circ$  rotation (analyzer out), and will remain extinct through a  $360^\circ$  rotation (analyzer inserted).

### Obtuse Bisectrix Figure ( $BX_O$ )

A  $BX_O$  figure will be similar to the  $BX_A$  figure, except that the melatopes will be outside of the field of view most of the time during a  $360^\circ$  rotation. Still, every  $90^\circ$  the broad cross will form as the OAP becomes parallel to one of the cross hairs.

### Optic Normal Figure (O.N.)

If the principal  $\beta$  direction of the indicatrix is oriented perpendicular to the stage, such that the crystal's privileged directions are  $\alpha$  and  $\gamma$ , then changing to conosccope mode will produce an optic normal figure, also called a *flash figure*. In this figure, when one of the two privileged directions lines up with the polarizer, a broad cross covering almost the entire field of view will be observed. This cross, however will quickly disappear after just a slight rotation of the stage (this is why it is often called a flash figure). If one sees an optic normal figure, then the interference colors observed in orthoscope mode will reflect the absolute or maximum birefringence of the mineral, as discussed above.

### Determination of Optic Sign

Biaxial interference figures are most useful for the determination of optic sign and estimation of the  $2V$  angle, both of which are useful diagnostic properties of biaxial minerals. The two most useful are the  $BX_A$  figure and OA figure.

### Acute Bisectrix Figure

To determine the optic sign of a biaxial mineral from a  $BX_A$  figure, position the isogyres so that the melatopes are in the NE and SW quadrants. There should be an area near the melatopes that shows a  $1^\circ$  gray interference color. Observe this area as you insert the 550nm or  $1^\circ$  red compensator. If the  $1^\circ$  gray area in region between the two isogyres turns yellow, the mineral is biaxial positive. If the  $1^\circ$  gray area inside of both the isogyres turns yellow the mineral is biaxial negative. Note that it is easiest to remember this if you imagine the area inside the isogyres turns yellow and a line drawn inside the isogyres crosses the slow direction of the compensator like the vertical stroke on a plus sign. For a negative mineral, the line connecting the two yellow areas is parallel to the slow direction in the compensator, forming the minus sign.

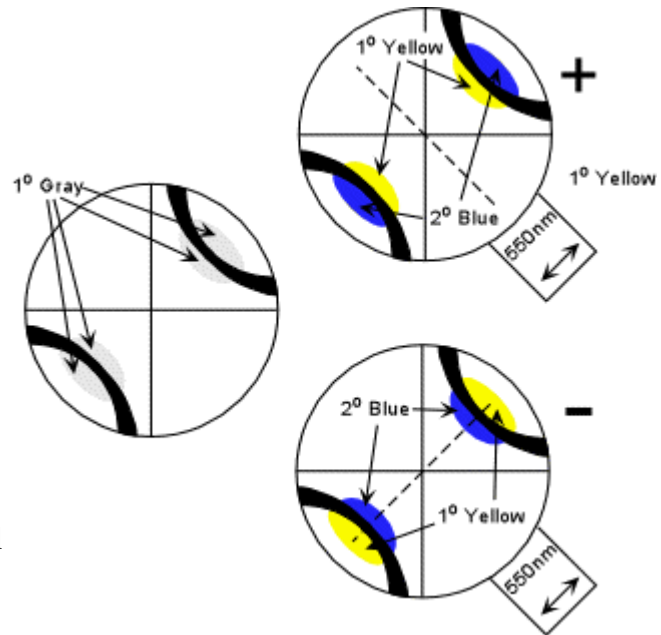

**Centered Optic Axis Figure**

Optic axis figures probably provide the easiest method for determination of optic sign because grains with an orientation that would produce an OA figure are perhaps the easiest to find.

The method is similar to the  $B_{XA}$  figure, except you will be looking at only one of the isogyres. Again place the isogyre so that the inside of the isogyre is in the NW quadrant. Find the area that shows 1° gray close to the melatope. Observe this area as the 550 nm compensator plate is inserted. If the area outside of the isogyre turns yellow, the mineral is biaxial positive. If the area inside the isogyre turns yellow, the mineral is biaxial negative.

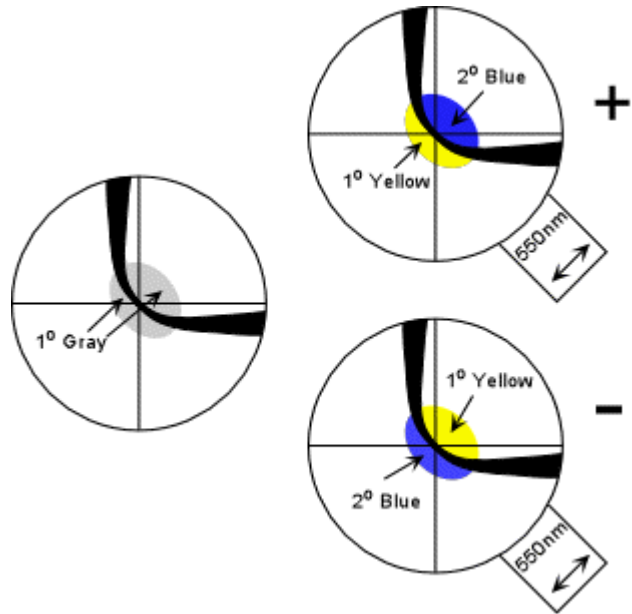

**Off-centered Figures**

Probably even easier to locate are off-centered OA or  $BX_A$  interference figures.

The method for optic sign determination in off-centered figures is essentially the same as for  $BX_A$  and OA figures. Position the isogyres so that it fits best in either the NE or SW quadrant. Observe the gray area near the melatopes and note the color change on insertion of the 550 nm compensator. If the gray area outside the isogyre turns yellow, the mineral is biaxial positive. If the gray area outside isogyre turns blue and the gray area inside the isogyre turns yellow, the mineral is biaxial negative.

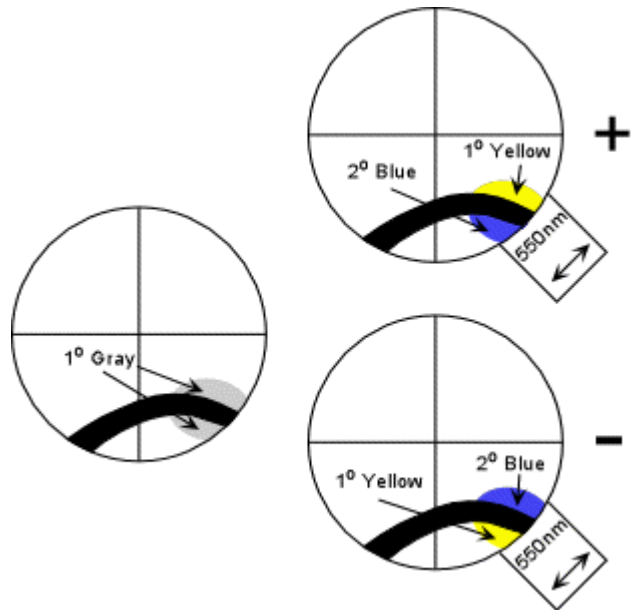

## How to Locate Different types of Biaxial Interference Figures

The best indicator of the type of interference figure a given grain will produce is the level of interference colors exhibited by the grain in orthoscope mode. Note that the O.N. figure will occur on grains that show the maximum interference colors. Such a grain will give the best indicator of the absolute birefringence of the mineral. OA. figures and Off-centered OA figures will be easiest to locate because the grain will either be completely extinct on a 360° rotation (OA figure) or will show very low birefringence (off-centered OA).

Type of Interference Figure	Level of Interference Colors
O.N.	Maximum
$B_{XO}$	Relatively High
$B_{XA}$	Relatively Low
O.A.	None
Off-centered O.A.	Very Low

## How to Distinguish Biaxial from Uniaxial Interference Figures

Biaxial minerals can often be distinguished from uniaxial minerals on the basis of an interference figure.

To do so, rotate the stage until the isogyre rests on intersection of the cross hairs. If there is any curvature to the isogyre, the mineral is biaxial. If the isogyre is straight, then the mineral is either biaxial with a low 2V or is uniaxial. In the latter case further tests will have to be made on other grains to make the distinction.

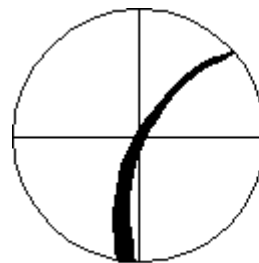

Definitely Biaxial

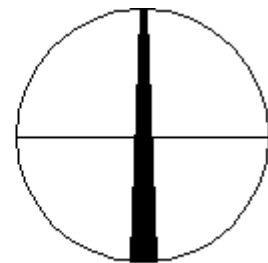

Uniaxial or Biaxial with low 2V

## Estimation of 2V

Precise determination of 2V can only be made by determining the 3 principal refractive indices of the mineral. But, 2V can be estimated from Acute Bisectrix figures and Optic Axis figures using the diagrams shown here.

**Acute Bisectrix Figure**

Recall that for a  $BX_A$  figure the distance between the melatopes is proportional to the  $2V$  angle. To estimate the  $2V$  from a  $BX_A$  figure, one first needs to know the numerical aperture (N.A.) of the objective lens used to observe the interference figure. The microscopes in our labs have an N.A. of 0.65, while research microscopes generally have a higher N.A. of 0.85. The diagram shown here gives a visual estimate of the  $2V$  angle for objective lenses with these two values of N.A. for a mineral with a  $\beta$  refractive index of 1.6.

Remember that if the  $2V$  is  $0^\circ$  the mineral is uniaxial, and would thus show the uniaxial interference figure. The separation of the isogyres or melatopes increases with  $2V$  and the isogyres eventually go outside of the field of view for a  $2V$  of  $50^\circ$  with the smaller N.A., and about  $60^\circ$  for the larger N.A.

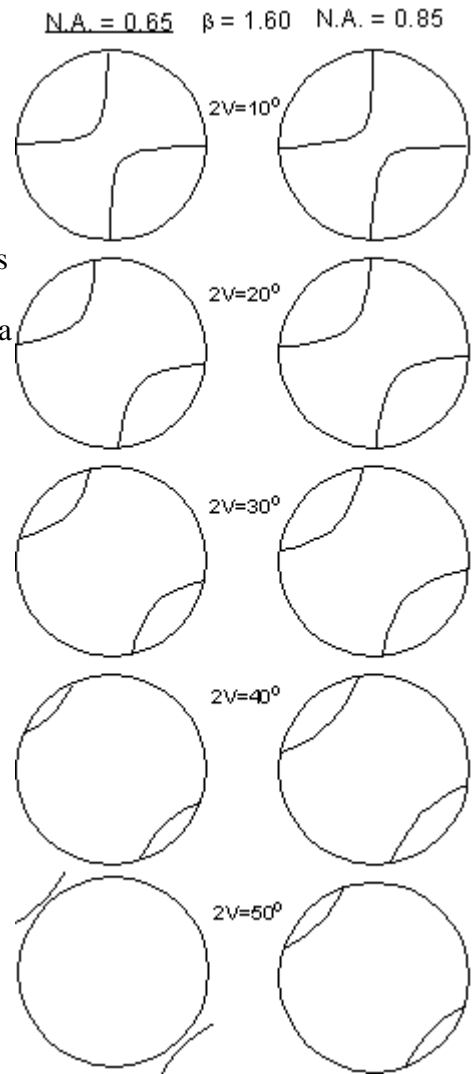

Since the maximum  $2V$  that can be observed for a  $BX_A$  figure depends on the  $\beta$  refractive index, the chart shown here may be useful to obtain more precise estimates if the  $\beta$  refractive index is known or can be measured.

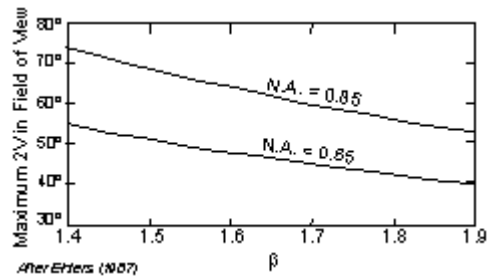

**Optic Axis Figure**

$2V$  estimates can be made on an optic axis figure by noting the curvature of the isogyres and referring to the diagram shown here. Note that the curvature is most for low values of  $2V$  and decreases to where the isogyre essentially forms a straight line across the field of view for a  $2V$  of  $90^\circ$ . For a  $2V$  of  $0^\circ$  the mineral is uniaxial and the isogyres form a cross with straight isogyres.

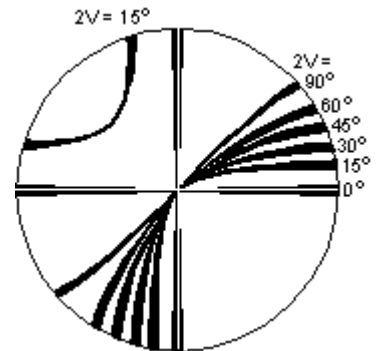

## Extinction Angle

Extinction angle is the property that involves determining the angle between the a crystallographic direction as exhibited by a crystal face or cleavage and one of the principal vibration directions. We have already discussed parallel and symmetrical extinction in uniaxial minerals. The concept is the same for Biaxial minerals, except that the extinction angles could be different from  $90^\circ$  or  $0^\circ$ , as is the case for parallel extinction.

Three different cases are observed depending on whether the mineral is orthorhombic, monoclinic, or triclinic.

### Orthorhombic Minerals

In orthorhombic minerals the principal vibration directions are coincident with the 3 crystallographic axes. Thus, for most orientations of the mineral on the stage, cleavages that are parallel to a crystallographic axis will show extinction that is parallel to or at  $90^\circ$  to such a cleavage.

Shown here on the left is an orthorhombic mineral with {010} cleavage. Since this cleavage is parallel to the a and c crystallographic axes, and since the  $\alpha$ ,  $\beta$ , and  $\gamma$  vibration directions are also parallel to the a, b, and c axes, this mineral will show parallel extinction with respect to the {010} cleavage.

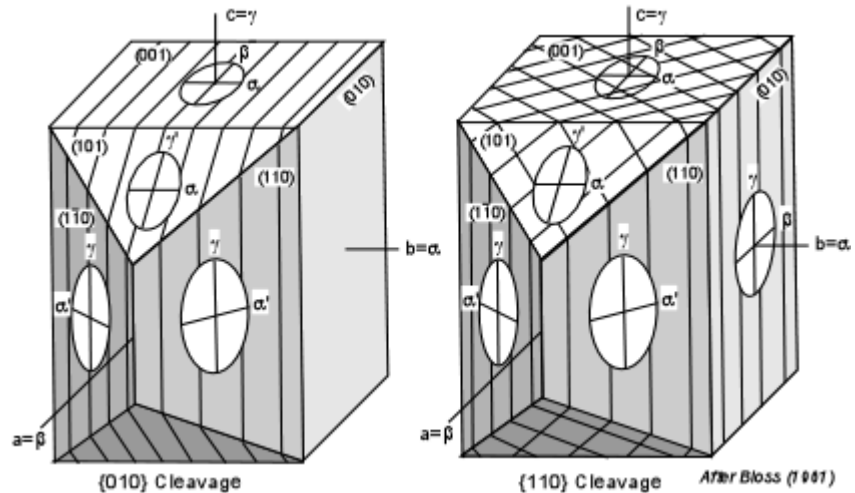

On the right is an orthorhombic mineral with {110} cleavage. Again, since the cleavage is parallel to the c crystallographic axis, and one of the principal vibration directions is also parallel to the c axis, the mineral will show parallel extinction if the mineral is lying on any face parallel to the c axis [i.e. (010), (110)] or any other random face such as (210), (130), etc. (not shown in the diagram).

If the crystal is lying on a face that is not parallel to the c axis, it will show symmetrical extinction with respect to the cleavages.

### Monoclinic Minerals

In monoclinic crystals, only one of the principal vibration directions will coincide with a crystallographic axis. The others will be at some angle to the crystallographic axes.

In the case shown here, a monoclinic mineral with  $\{110\}$  cleavage will show extinction at some angle other than  $0^\circ$  or  $90^\circ$  to the cleavage direction. This angle will vary from some maximum angle to  $0^\circ$ , depending on which crystal face is parallel to the stage. In the case shown here, the maximum angle will be seen if one is looking down the  $b$  axis or  $\beta$  direction, that is the face  $(010)$  [or  $(0\bar{1}0)$ ]. Only if the  $(100)$  face is parallel to the stage will parallel extinction be observed.

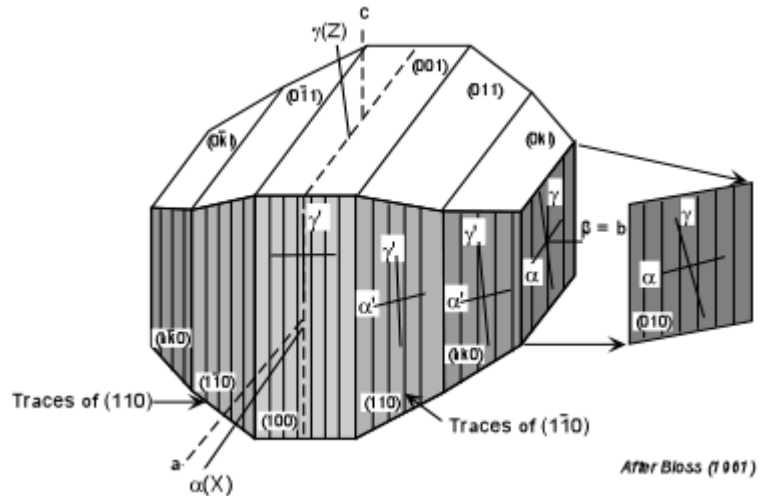

This is important, because if a mineral is reported to have inclined extinction with respect to a cleavage, note that it is possible, given the right orientation of the grain, for the mineral to exhibit parallel extinction.

For minerals that show inclined extinction, tables of determinative properties usually list the maximum extinction angle in the form  $\gamma \angle c$  or  $Z \angle c$ .

### Triclinic Minerals

In triclinic minerals none of the principal vibration directions are constrained to coincide with crystallographic directions. Thus, asymmetrical and inclined extinction are to be expected. Again, in tables of determinative properties of minerals the maximum extinction angle will be given in a form such as  $\gamma \angle c$  or  $Z \angle c$ . Also, note that there will be some orientation of the grain where the extinction will be parallel, so extinction angle should be tested on several grains of the same mineral.

### Sign of Elongation

For minerals that commonly show an elongated habit, the sign of elongation could be an important property. In biaxial minerals sign of elongation is only important if the mineral tends to be elongated in the direction of either  $\gamma$  or  $\alpha$ , since these are the maximum and minimum refractive indices. Sign of elongation is determined by positioning the grain so that its elongation direction is parallel to the slow direction of the compensator. Before inserting the compensator find an area near the edge of the grain that shows a  $1^\circ$  gray interference color. If the gray area turns blue then the mineral's slow direction ( $\gamma$  direction) is parallel to the slow direction in the compensator. If the gray area turns yellow, then the mineral's fast direction ( $\alpha$  direction) is parallel to the slow direction in the compensator.

Note that sign of elongation is usually not reported for minerals that are elongated in the  $\beta$  direction, since some faces would show length fast, and other faces would show length slow.

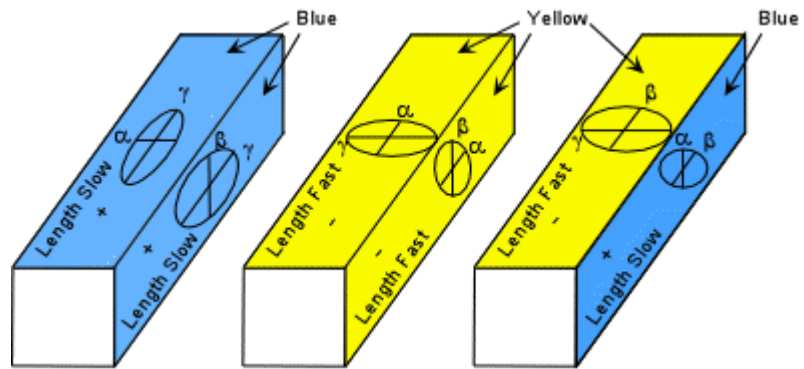

### Pleochroism

As discussed under uniaxial minerals, pleochroism is the property where the mineral shows a different absorption color associated with different vibration directions. In uniaxial minerals the two main vibration directions could have different absorption colors, and any intermediate direction would show an intermediate color. In biaxial crystals, three different absorption colors are possible, one associated with each of the principal indices. Intermediate directions will give intermediate colors.

The pleochroic formula is usually given in terms of the three principal refractive indices, for example a biaxial mineral could have the pleochroic formula  $\alpha = \text{red}$ ,  $\beta = \text{pink}$ ,  $\gamma = \text{clear}$ .

Of course, since only two vibration directions can be observed at any one time, only two of the colors will be seen on rotation of a given grain. Thus, several grains of the same mineral must be observed in order to determine the pleochroic formula of the mineral.

### Other Observations

We here discuss some other properties that may be exhibited by some minerals. If any of these occur, they may be useful diagnostic features of the mineral.

### Zoning

Zoning occurs as a result of incomplete reaction of solid solutions and results in the chemical composition of the mineral changing through the mineral. Optical properties, depend on chemical composition, and thus if the composition changes through a crystal, the optical properties will vary through the crystal as well. In particular, the orientation of the principal vibration directions may change, and thus the angle at which the mineral goes extinct may change. This can be observed by rotating a zoned crystal and noting that the whole crystal does not go extinct all at once. Each part that goes extinct at the same time or has the same interference color at the same time has a chemical composition distinct from other parts of the same crystal.

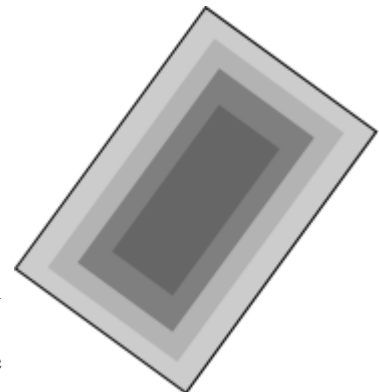

## Twinning

Since twinning is an intergrowth of two or more crystals, optical properties will change at the boundaries between twins.

Thus, different parts of the crystal will go extinct at different times as a result of twin planes. Plagioclase polysynthetic twinning is seen as dark and light colored stripes running through the crystal under crossed polars (left-hand illustration). Cyclical twins and simple contact twins are shown in the other illustrations.

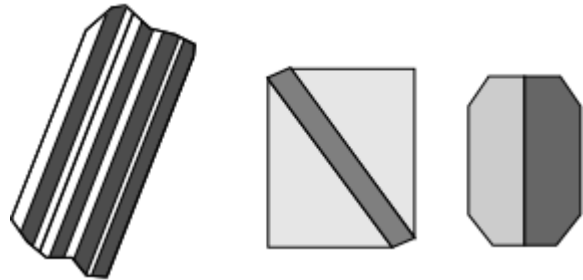

## Exsolution Lamellae

Some minerals that form solid solutions at high temperature exsolve as they pass through lower temperatures. This exsolution often results in domains of one mineral inside of the other, called exsolution lamellae. This is very common in the alkali feldspars that occur in plutonic igneous rocks, as shown here. It also occurs in other minerals, particularly the pyroxenes. When exsolution lamellae are present, they can be very diagnostic of the mineral.

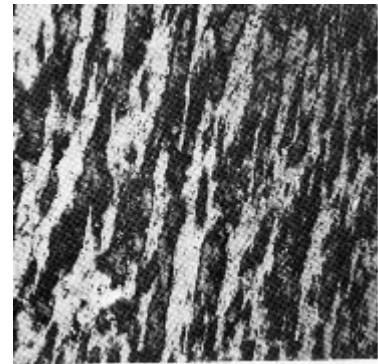

Exsolution Lamellae in Alkali Feldspar

## Undulatory Extinction

Deformation of minerals can result in strain of the crystal structure, which causes different parts of the same mineral to have different crystallographic and therefore optical orientations. When this occurs, the parts of the crystal with different orientations will go extinct at different rotational positions. This is referred to as undulatory extinction. It is common in quartz found in metamorphic rocks.

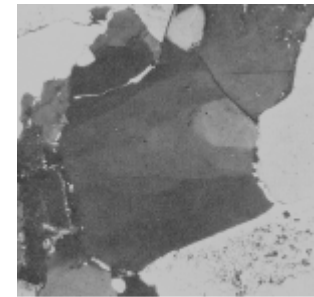

Undulatory Extinction in Quartz

## Abnormal Interference Colors

As discussed under uniaxial minerals, if a mineral has strong absorption of certain wavelengths of light, these same wavelengths will be absorbed by the crystal with the analyzer inserted, and thus the crystal may produce an abnormal or anomalous interference color, one that is not shown in the interference color chart. For example, imagine a crystal that shows strong absorption of all wavelengths of light except green. Thus, all other wavelengths are absorbed in the crystal and the only wavelengths present that can reach the analyzer are green. The crystal will thus show a green interference color that is not effected by the other wavelengths of light, and thus this green color will not appear in the interference color chart. When a mineral exhibits abnormal interference colors, it will usually be listed as one of the diagnostic properties.

## Associations

Some minerals commonly occur with other minerals in the same rock due to the chemical composition of the rock. Likewise, some minerals do not occur in association with other minerals. Mineral associations can be very useful diagnostic properties. For example, nepheline and quartz do not usually occur with one another, nor does Mg-rich olivine and quartz. Thus, if you see quartz in a rock, you will not likely find Mg-rich olivine or nepheline. Aluminous schists, result from metamorphism of shales, which contain an abundance of Al-rich clay minerals. So, we expect to find Al-rich minerals in aluminous schists, like garnet, muscovite, alkali feldspar, biotite, and an  $\text{Al}_2\text{SiO}_5$  mineral like kyanite, andalusite, or sillimanite.

Mineral associations often make mineral identification much easier because you know what minerals to expect. These will be discussed to a much greater extent in EENS 2120, Petrology. In your Deer, Howie and Zussman book, mineral associations are referred to as *Paragenesis*.

## Summary of Optical Properties

- **Determination of Isotropic, Uniaxial, or Biaxial Character**

Mineral is

- Isotropic if all grains are extinct under crossed polars during  $360^\circ$  rotation.
  - Uniaxial if it gives a uniaxial interference figure.
  - Biaxial if it gives a biaxial interference figure.
- **Estimation of Birefringence** - in thin section with thickness of minerals of 0.03 mm, birefringence is estimated using interference color chart. Note that only absolute birefringence is diagnostic:

$|\omega - \varepsilon|$  for uniaxial minerals

$(\gamma - \alpha)$  for biaxial minerals

- **Optic sign** -

- from uniaxial centered or near centered interference figure for uniaxial minerals.
  - from biaxial  $\text{BX}_A$  or OA centered or near centered interference figure.
- **Relief** - from comparison with surrounding minerals or cement in which the crystals are mounted, or with oil in immersion method.
  - **2V** - for biaxial minerals only, estimated with  $\text{BX}_A$  or centered OA figure
  - **Absorption Color or Pleochroism**

- Absorption color - if present, may be observable in isotropic, uniaxial, and biaxial minerals with analyzer not inserted.
- Uniaxial minerals may have pleochroic formula:  $\omega$  = color1,  $\varepsilon$  = color2. If optic axis is perpendicular to the stage, only one color will be observed.
- Biaxial minerals may have pleochroic formula  $\alpha$ = color1,  $\beta$  = color2,  $\gamma$  = color3, but only 2 colors will be observed in any one grain, unless the optic axis is perpendicular to stage - then only one color.

- **Sign of Elongation**

- For uniaxial minerals that are elongated parallel to the C axis, sign of elongation will + or slow if the mineral is optically positive, and - or fast if the mineral is uniaxial negative. For minerals that do not show an elongated habit this property is not reported.
- For biaxial minerals that are elongated parallel to  $\gamma$ , the sign of elongation will be + or length slow. If they show a habit elongated parallel to  $\alpha$ , the sign of elongation will be - or length fast. If the mineral does not commonly show an elongated habit or if it is elongated parallel to  $\beta$ , the sign of elongation will not be reported.

- **Extinction Angle**

- Uniaxial minerals that have cleavage parallel to the c axis will have parallel extinction on all faces lying with the c axis parallel to the stage, and have symmetrical extinction on all other faces if the cleavages intersect.
- Biaxial minerals that have cleavage parallel to the c axis will usually have inclined and asymmetrical extinction if the mineral is triclinic or monoclinic, and will have parallel and symmetrical extinction if the mineral is orthorhombic. Extinction angles that reported will be the maximum possible acute angle, and thus different orientations of the minerals could produce extinction angles from 0 to 45°.

- Other Properties, as discussed above

- zoning
- twinning
- exsolution lamellae
- undulatory extinction
- abnormal interference colors

---

**Examples of questions on this material that could be asked on an exam**

1. What is the correspondence between the three principal vibration directions and the crystallographic axes in biaxial crystals?

2. How is the optic sign of biaxial crystals defined? Give two different ways.
3. Draw a centered  $BX_A$  figure for a mineral that is highly birefringent with a positive  $2V = 30^\circ$ . Show the isogyres in the northeast and southwest quadrants. On the diagram label the following: (a) melatope(s), (b) isogyres, (c) isochromes, and (d) the  $2V$ . Indicate the effect of inserting the first order red compensator, by showing the compensator and its slow direction along with any color changes that might occur in the interference figure.
4. For a biaxial or uniaxial mineral give as many methods as you can for locating a grain in which the optic axis will be oriented perpendicular to or nearly perpendicular to the microscope stage.
5. Define the following: (a) sign of elongation, (b)  $2V$  angle, (c) extinction angle, (d) undulatory extinction, (e) abnormal interference color, (f) pleochroism.

---

[Return to EENS 2110 Page](#)